

# SHELVING/INFORMATION KITS - DECORATIVE GLASS SHELVES

Cable/Rod suspended shelves are a quick and easy way to create high impact presentations, that communicates your message simply and effectively, and works in harmony with any environment. They can be completely customized to co-ordinate with any design scheme. Sets you free to totally integrate product displays, graphics and lighting, to produce the most stylish presentations...

## Mounting Options

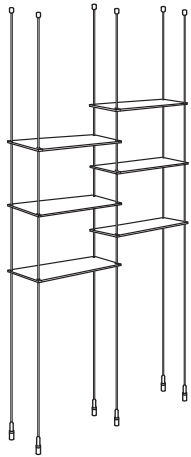

Ceiling to Floor Shelving

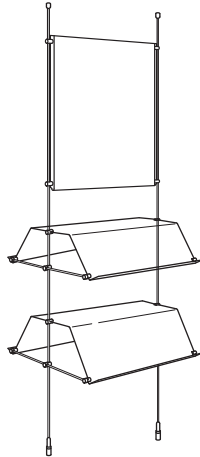

Ceiling to Floor Sloping Shelves

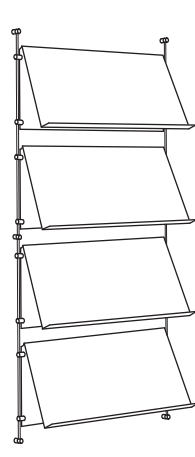

Wall Mounted Angled Shelves

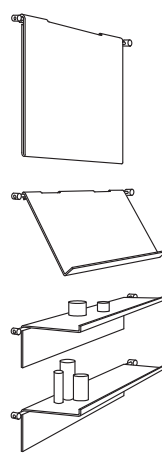

Wall Mounted Hook-on Shelves

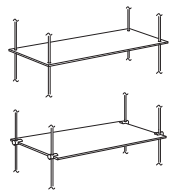

Drilled/Slotted or Plain Glass Shelves

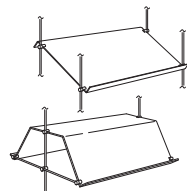

Angled or Sloping Acrylic Shelves

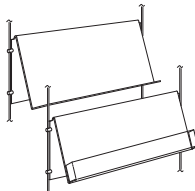

Angled Shelves & Dispensers

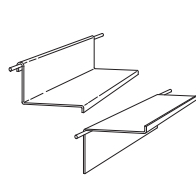

Drop-hook and Hook-on Shelves

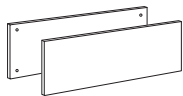

Acrylic Screens & Logo-Panels

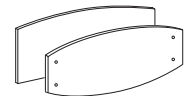

Shaped Acrylic Panels

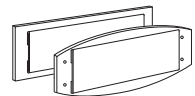

Acrylic Message Boards



Custom Shaped Logo-Panels

Create impressive screens, backgrounds, and logo-panels using clear, frosted, or colored acrylic with vinyl lettering or ink-jet prints...

Increase visual impact, by adding to your product display custom shaped panels with graphics or text...

Use panels with acrylic pockets for easy message change. Ideal for permanent or temporary text and graphics display...

Create high quality branding with custom shaped logo-panels and extruded letters and corporate logos...

## Shelving Configurations

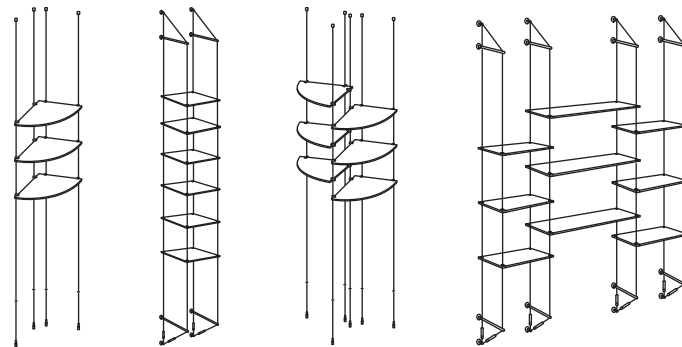
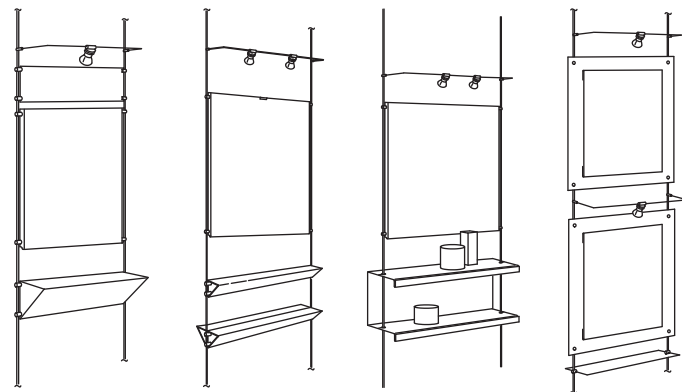
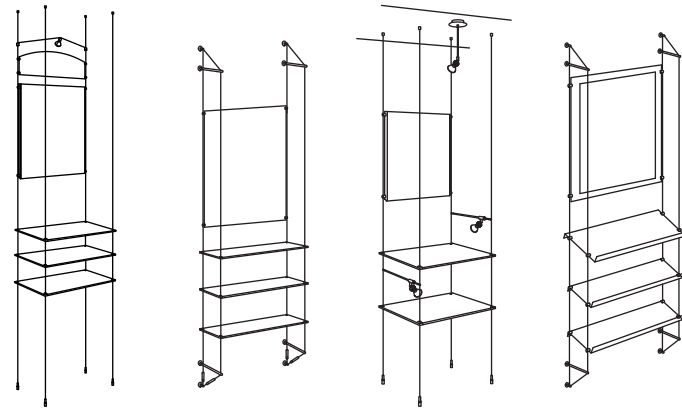

## LOW-VOLTAGE LIGHTING

### HOW MANY LIGHTS CAN I PUT ON ONE PAIR OF CABLES?

The answer to this lies in the type of light you have selected.

Single lights are powered on a 12V system and are supplied with a 60W transformer.

This means on one pair of cables fitted with a 60W transformer you can have:

1 x 50W Light

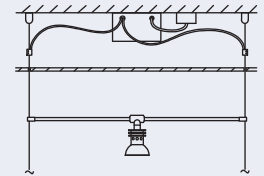

or

Up to 3 x 20W Lights

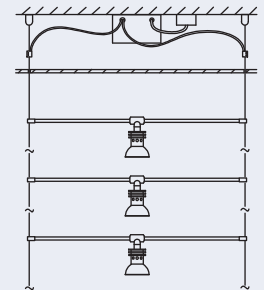

Double lights are powered on 24V system and are supplied with a 100W transformer.

This means on one pair of cables fitted with a 100W transformer you can have:

2 x 50W Lights

