

Acrylic-Rod Ornament Hangers

There are two styles of our clear acrylic-rod hangers; some are made with 1/4"-diameter rod and some with 3/16"-diameter rod for lighter items and a more delicate look.

Product No.	Height	Space	Rod Dia.
HB6	3 3/4	3	3/16
HB1	5 1/8	4 1/2	1/4
HB4	5 1/8	4 1/2	3/16
HB81	6 5/8	6	1/4
HB82	6 5/8	6	3/16
HB3	8 1/4	7 3/4	1/4

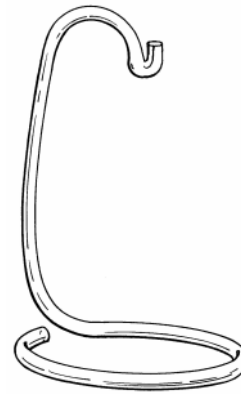

Acrylic Crescent Ornament Hangers

3/4"-square base. Base and hanger are shipped separately and assemble with a screw.

Product No.	Height	Space
CWH1	6 1/2	5 1/2
CWH3	8 1/4	7 1/2
CWH5	10 1/4	9 1/2
CWH5T *	10 1/4	9 1/2

* Thicker acrylic for heavier ornaments.

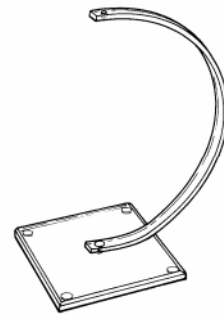

Gold-Plated Ornament Hangers

Hangers with Economy Bases

3/4" square, clear or black.

Product No.	Finish	Space	Height
WH1	Clear	4 1/2	5 1/2
WH1B	Black	4 1/2	5 1/2
WH3	Clear	6	7 1/2
WH3	Black	6	7 1/2



Hangers with Wood Bases

Product No.	Base Dia.	Space	Height
WH1W	3 3/4	4 1/2	5 1/2
WH3W	4 3/4	6	7 1/2



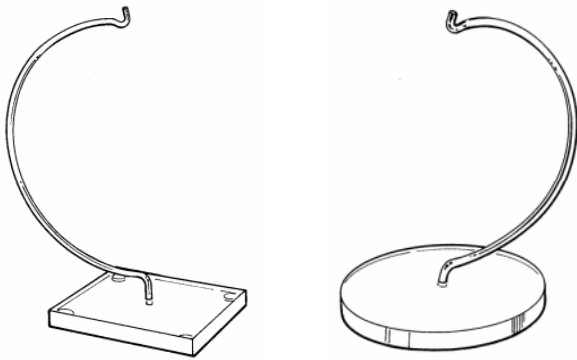

Hand-Made Acrylic Base Hangers

Gold plated wire on square or round base.

Product No.	Base	Space	Height
WH1Y	$\frac{3}{8}$ x 3 x 3	4½	5½
WH3Y	$\frac{3}{8}$ x 4 x 4	6	7½
WH1R	$\frac{3}{8}$ x 3½ dia.	4½	5½
WH3R	$\frac{3}{8}$ x 3½ dia.	6	7½

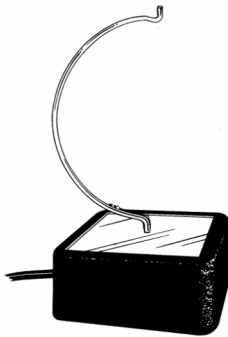

Lighted Ornament Display

Hang an ornament on this gold-plated wire and light box combination and accent it with light from underneath. Display includes a 7-watt bulb and 6-foot cord with in-line switch.

Product No.	Space	Height
LB8	4½	7¼

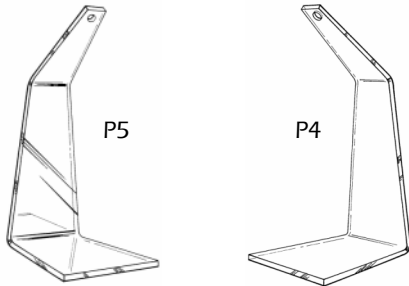

Economy Ornament Hangers

These displays are offered in both clear and mirror finish.

Product No.	Finish	Space	Height
P4	Clear	6	6½
P5	Mirror	6	6½
P6	Mirror	8	8½

Multi-Ornament Displays

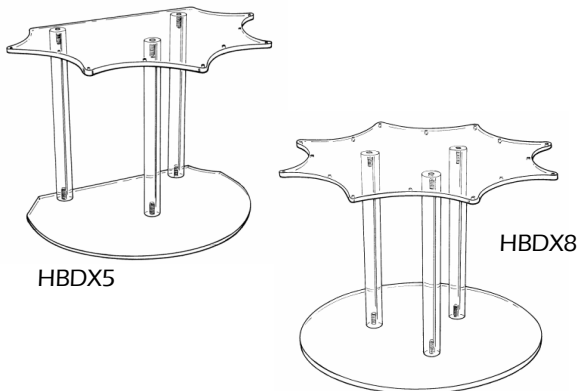

Ornament Risers

Hang ornaments and utilize the top platform for an eye-catching display. These easy-to-assemble displays are constructed with acrylic rods and stainless-steel screws and pack flat.

Product No.	Ornaments	H x W x D
HBDX5	9	8½ x 12½ x 9
HBDX8	16	8¾ x 12½ x 12½
HBDX88	32	16½ x 12½ x 12½

HBDX88 is a two tier version of the HBDX8.

Ornament Trees

These trees fit into a solid acrylic base (3" x 6") and display ornaments in six 4"-diameter holes.

Product No.	H x W
HB2	17 x 17½
HB75	17 x 19
HB7	17 x 17½

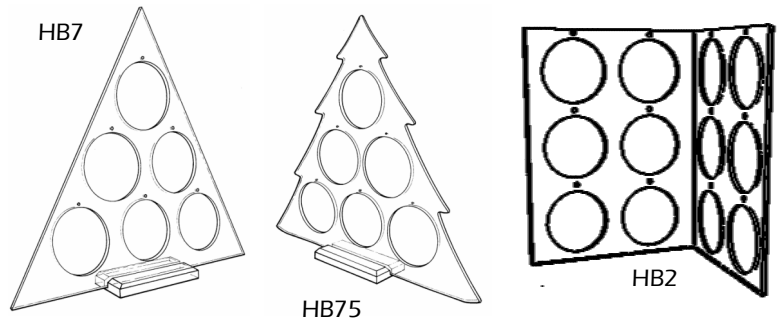

Tiered Ornament Trees

Three- and four-tiered versions of this ornament hanger hold 36 and 54 ornaments.

Product No.	Ornaments	H x Dia.
TOT3	36	19¼ x 16
TOT4	54	25¾ x 20½

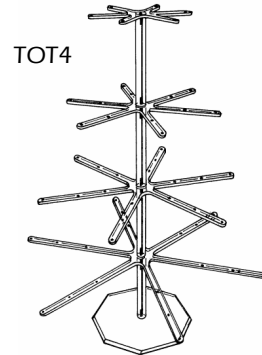

Hanging Tiered Ornament Trees

Both three- and four-tiered versions of this display are designed to hang from the ceiling. Add motion with battery operated turner, sold separately.

Product No.	Ornaments	H x Dia.
TOT3H	36	12¾ x 16
TOT4H	54	19 x 20½

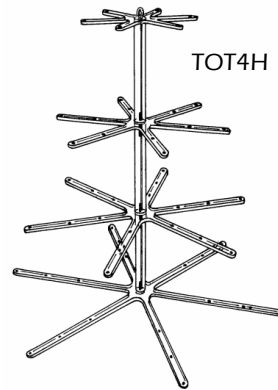

Ornament Displays

Call attention to displays with motion by hanging them on this battery operated turner. Uses one "D" battery (not included). Holds up to 5 pounds.



Product No.	Height
RVBT1	6½

Spiral Hanging Display

This very popular ceiling hanger comes with bendable soft wire hooks. Add interest to displays with constant motion provided by a battery operated turner. (Sold separately.)

Product No.	Ornaments	H x Dia.
HBO	12	27½ x 8½

